

ring

Plug-in Adapter

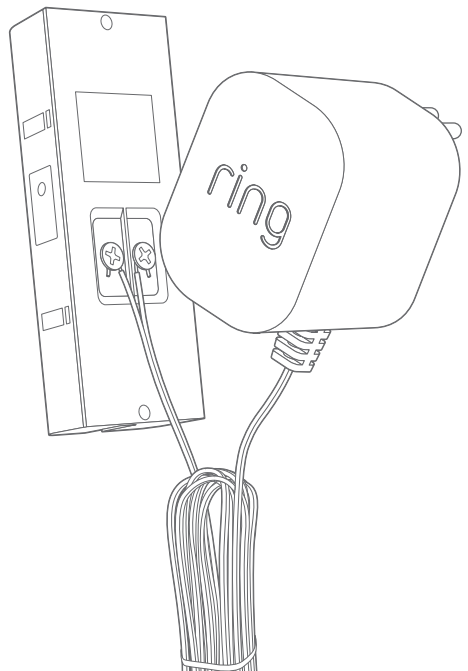

Welcome

This kit contains a plug-in power adapter for Ring Video Doorbell Pro.

It is intended for use in homes without doorbell systems, or when an existing system is unusable.

This manual is for informational purposes only. Working with electricity can be dangerous unless proper safety precautions are taken. If you are not comfortable or are inexperienced with the processes and tools described in this manual, we recommend that you hire a qualified electrician.

What's in the Box?



Cable Clips

Use to route the power cable along your walls

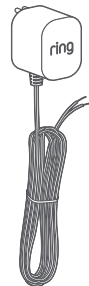

Plug-in Adapter

Use to convert household power to the voltage required for your Ring Video Doorbell Pro.

1. Choose an Outlet

Select a power outlet near the door where you plan to install your Ring Video Doorbell Pro.

Note: Don't plug the power adapter in yet!

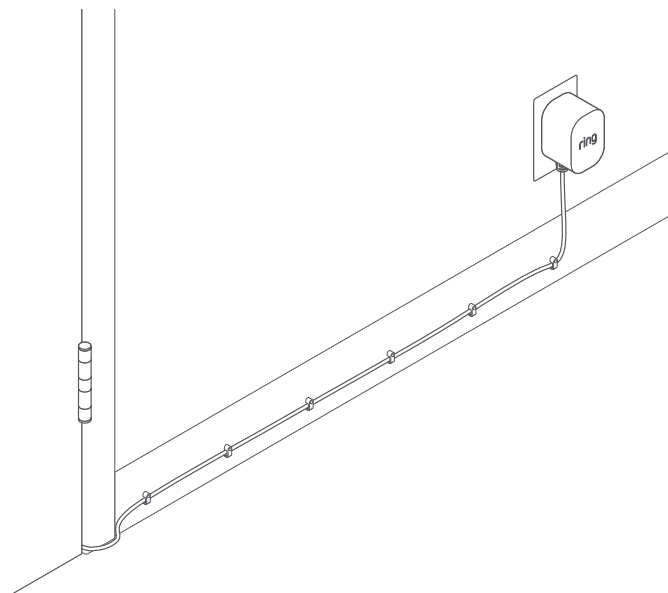

2. Run the Cable

Run the cable down from the outlet to your moulding, and then choose a path to your Ring Video Doorbell Pro. Secure the cable to the wall with the provided cable clips.

The cable can be run through your walls, or through a door or window, if desired.

Note: Always be careful of existing electrical wiring and pipes when drilling through walls.

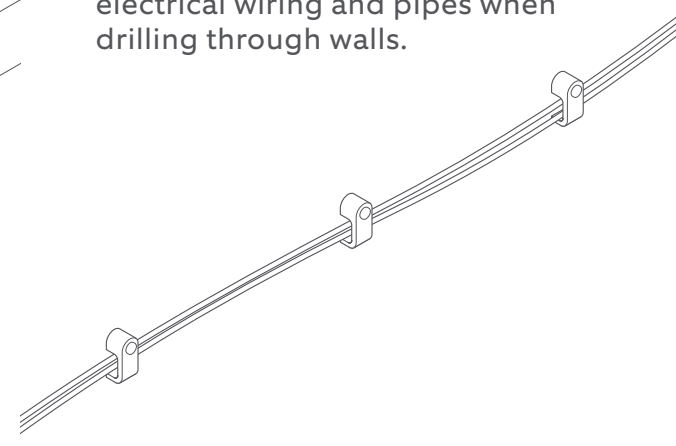

3. Attach the Wires

Attach the power cables to the terminals on the rear of your Ring Video Doorbell Pro.

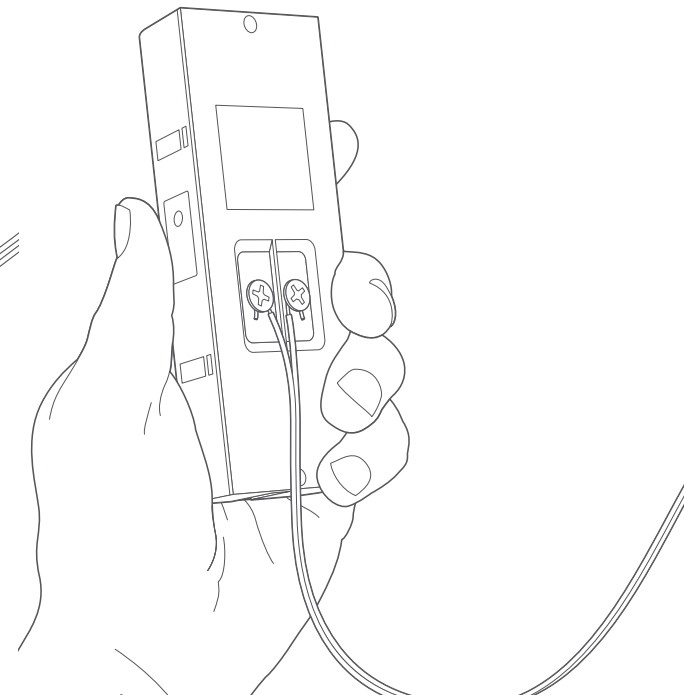

4. Plug in the power adapter

The front light on your Ring Video Doorbell Pro should illuminate to indicate that it is powered properly.

If your Ring Doorbell has never been set up, the front light will spin, indicating that your Ring Pro has entered Setup Mode.

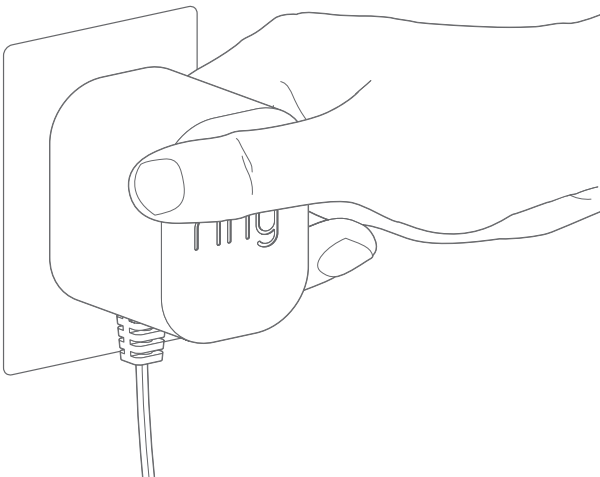

5. Install your Ring Video Doorbell Pro

If you haven't already, mount and set up your Ring Video Doorbell Pro according to the provided instructions.



6. Set Doorbell Type to None

Note: Do not skip this step, or your Ring Doorbell may be damaged.

In the Ring app, select your Ring Doorbell Pro, then tap the gear icon and select **Doorbell Kit Settings**.

Select **None**, and save your settings.

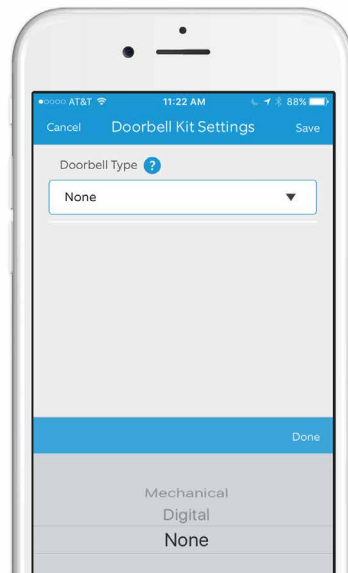

7. Test Your Ring Doorbell

Push the button on the front of your Ring Doorbell to try it out!

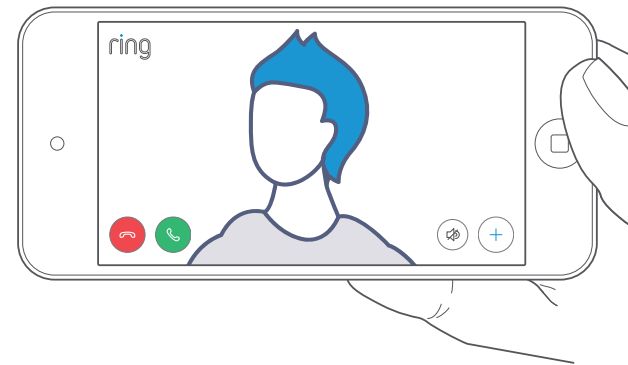

Hereby, Ring Inc. declares that this consumer electronic is in compliance with the essential requirements and other relevant provisions of Directive 1999/5/EC. The declaration of conformity may be consulted at www.ring.com/DoC.pdf.

This device complies with Part 15 of the FCC Rules and with Industry Canada licence-exempt RSS standard(s). Operation is subject to the following two conditions: (1) this device may not cause harmful interference, and (2) this device must accept any interference received, including interference that may cause undesired operation. Modifications to this equipment not authorized by Ring Inc. may void its approval for operation.

Do not cover the device while operating. Do not open the housing. Protect this device from sunlight. Disconnecting the plug will power the device off. Do not use the device if the plug or housing is defective, there is a risk of electric shock.

Warning: Changes or modifications to this unit not expressly approved by the party responsible for compliance could void the user's authority to operate the equipment. This equipment should be installed and operated with minimum distance 20 cm between the radiator & your body.

NOTE: This equipment has been tested and found to comply with the limits for a Class B digital device, pursuant to Part 15 of the FCC Rules. These limits are designed to provide reasonable protection against harmful interference in a residential installation. This equipment generates, uses and can radiate radio frequency energy and, if not installed and used in accordance with the instructions, may cause harmful interference to radio communications.

However, there is no guarantee that interference will not occur in a particular installation. If this equipment does cause harmful interference to radio or television reception, which can be determined by turning the equipment off and on, the user is encouraged to try to correct the interference by one or more of the following measures:

Reorient or relocate the receiving antenna.

Increase the separation between the equipment and receiver.

Connect the equipment into an outlet on a circuit different from that to which the receiver is connected.

Consult the dealer or an experienced radio/TV technician for help.

This Class B digital apparatus complies with Canadian ICES-003.

This device complies with Industry Canada license-exempt RSS standard(s).

Operation is subject to the following two conditions:

1) This device may not cause interference, and

2) This device must accept any interference, including interference that may cause undesired operation of the device.

Allow fixture to cool before handling.

Do not cut any wires with factory installed wire connectors or remove the wire connectors. Do not install on circuits feeding motor loads such as kitchen appliances, HVAC equipment, washer/dryer or garage door openers.

Do not install when it is raining.

Do not stare directly at the LEDs for more than a few seconds to avoid eye injury.

Do we need to include all the electrical qualifications this light meets? Tech Specifications, Guarantee

FIRE RISK: Do not mount near combustible or flammable surfaces.

Floodlight Cam does not serviceable parts or replaceable LEDs

Floodlight Cam should be installed outdoors to a wall or eaves, not the ground.

Instructions do not cover everything

These instructions do not claim to cover all details or variations in equipment or provide every possible contingency to meet in connection with the installation, operation or maintenance.

Risk of electric shock. Disconnect power at the fuse or circuit breaker before installing.

RISK OF ELECTRICAL SHOCK

- Disconnect power at the fuse or circuit breaker before installing.

- Verify that the supply voltage is correct. Connect fixture to a 100 VAC-240 VAC 50/60 Hz power source.

- Properly ground fixture.

- Always install wiring connections in accordance with local code standards.

© 2017 Ring Inc.

RING, ALWAYS HOME, and CHIME are trademarks of Ring Inc.

For additional help, visit:
ring.com/help

Or give us a call...

[US 1 800 656 1918](tel:18006561918)

[UK 01727 263045](tel:441727263045)

[AU 1 300 205 983](tel:1300205983)

[NZ +64 9 887 9871](tel:6498879871)

[Mexico \(D.F\) 52 55 8526 5445](tel:525585265445)

[Worldwide +1 310 929 7085](tel:13109297085)

For a list of all our customer support numbers, visit: ring.com/callus