

ring



Solar Floodlight
Smart Lighting

Download the Ring app.

The Ring app walks you through setting up and managing your Floodlight.

Search for “Ring” in one of these app stores, or visit: ring.com/app.



Set up your Ring Bridge.

The Bridge is required to connect your Ring Smart Lights to the Ring app and other compatible Ring devices.

To set up your Bridge, follow the instructions in the Ring app or the Bridge user manual.



Remove the back cover.

Twist your Floodlight counter-clockwise to unlock and separate it from the back cover.

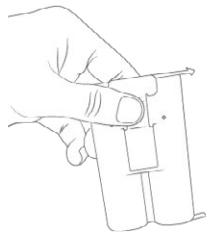
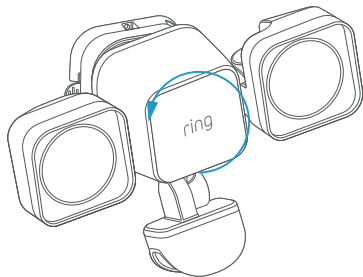

Remove the battery.

Push the metal tab and remove the included battery from the battery compartment.

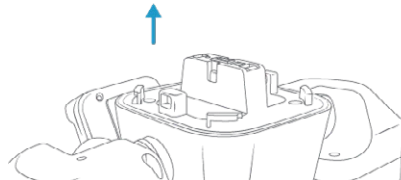

Remove the battery strips.

Carefully remove and discard them.

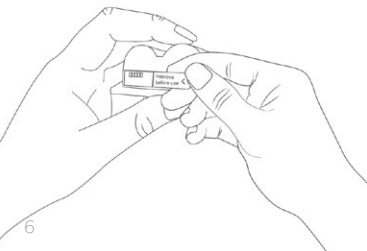

6

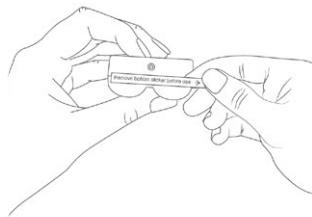

Charge the battery.

Fully charge the battery by plugging it into a power source using the provided orange cable. Once only one light is lit, it's fully charged.

 = Charging  = Charged

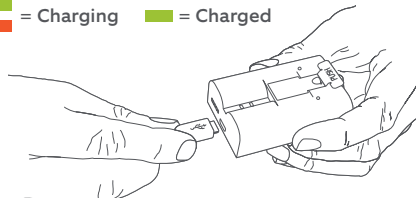

7

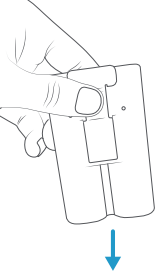

Insert the battery.

Insert the included battery and push until it snaps in place.

If you like, you can purchase and insert a 2nd battery to make your Floodlight last longer when bright sunlight is rare.

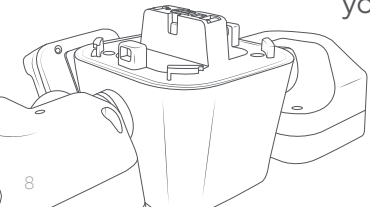

Set up your Floodlight in the Ring app.

In the app, tap **Set Up a Device**.

When prompted, select **Smart Lighting** and follow the in-app instructions.

After setup, replace the back cover (be sure to line up the arrows).

Remove the mounting plate.

Press the tab on the side and slide the mounting plate off of the back cover.

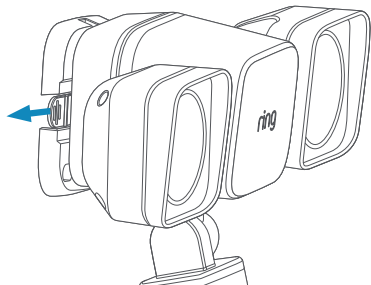

Mark pilot holes.

Mark your holes using the mounting plate as a guide, making sure the "UP" arrow is pointing upwards.

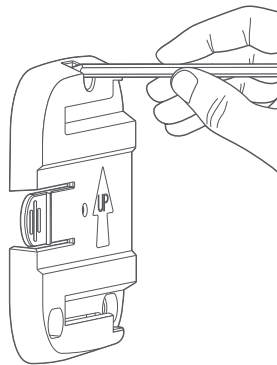

Install the mounting plate.

If installing on a masonry surface (such as stucco or brick), first drill holes using a 3/16" drill bit. Insert the wall anchors before inserting the screws.

If installing on a wood surface, you can screw the plate directly into your wall using a Philips head screwdriver.

Drive the screws.

Hold the mounting plate firmly against the surface and drive the three mounting screws.

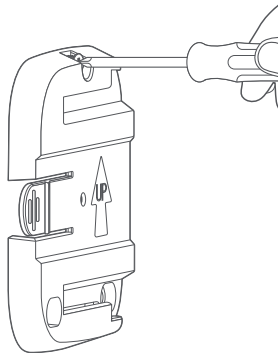

Mount your Floodlight.

Align your Floodlight with the mounting plate and slide it to the left to lock it in.

Next, let's set up your Ring Solar Panel.



The motion sensor is adjustable. Try various angles to find the best setting for your home.

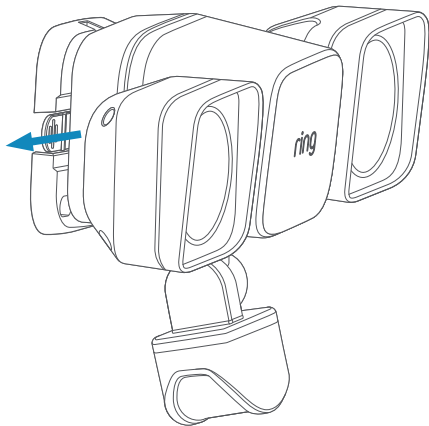

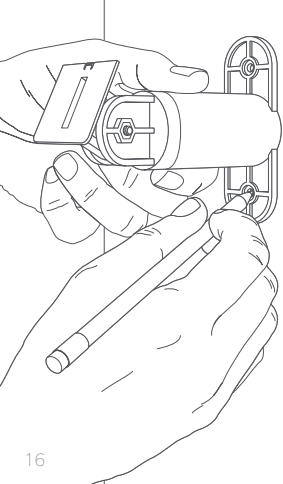

Mark pilot holes.

Select an install location within 13 feet of your Floodlight, where the Solar Panel can get direct sunlight.

Mark the holes using the mounting arm as a template, and refer to page 12 to install wall anchors (if needed).

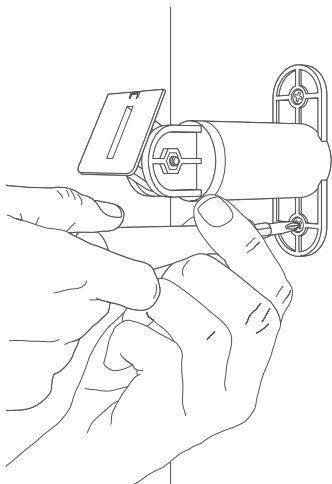

Screw in the Mounting Arm.

Drive the included mounting screws into your wall (or the wall anchors, if installing on a hard surface) until the mounting arm is secure.

Attach the Solar Panel.

Position the slots in the rear of your Solar Panel over the mounting arm and slide it down to secure it.

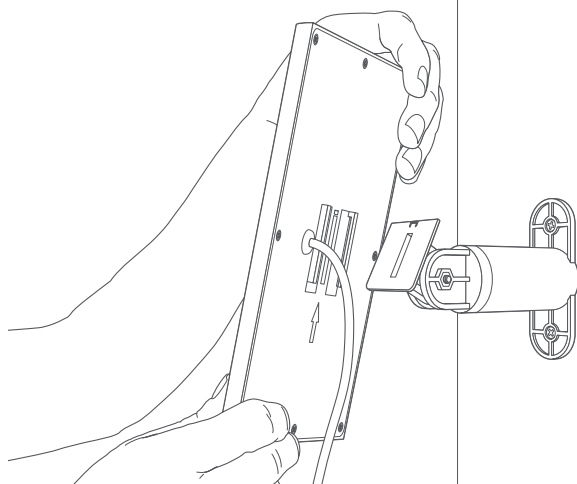

Adjust the Angle.

Loosen the screw on the mounting arm and adjust the panel to your desired angle, then re-tighten the screw to secure your setting.



You can rotate and tilt your Solar Panel to get the best orientation for your home.

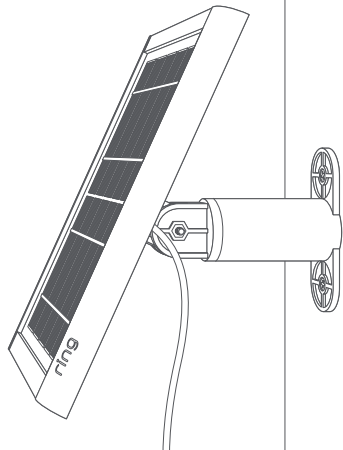

Connect the cable.

Once your Solar Panel is mounted, insert the power plug into the power input at the bottom of your Floodlight.

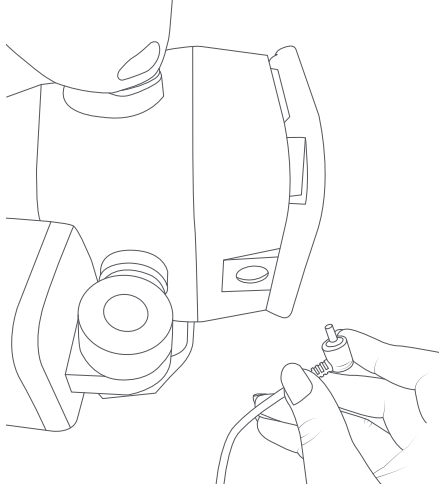

For additional help, visit: ring.com/help

Or give us a call...

[US 1 800 656 1918](tel:18006561918)

[Canada 1 855 300 7289](tel:18553007289)

[Worldwide +1 310 929 7085](tel:+13109297085)

For a list of all our customer support numbers,
visit: ring.com/callus

© 2019 Ring LLC or its affiliates.

Ring and all related logos are trademarks of Ring LLC or its affiliates.