

# Setup Guide Guide de configuration Guía de instalación

Spotlight Cam Plus | Battery

 [ring.com/manuals](https://ring.com/manuals)

Download the full manual online.  
Téléchargez le manuel complet en ligne.  
Descarga el manual completo en línea.

## Hardware included / Matériel inclus / Materiales incluidos

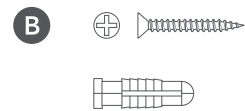

## Tools needed / Outils requis / Herramientas necesarias



**!** Remove protective film / Retirer le film protecteur /  
Retira el plástico protector



Continue setup in Ring app / Poursuivre la configuration dans  
l'application Ring / Continúa la configuración en la app de Ring

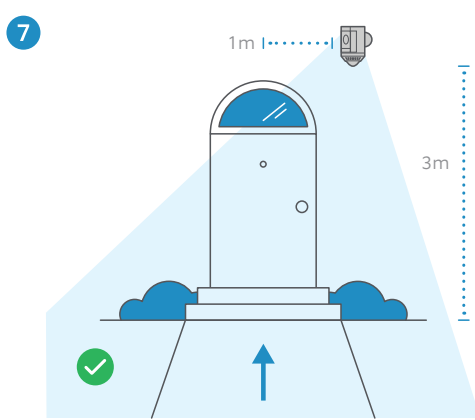
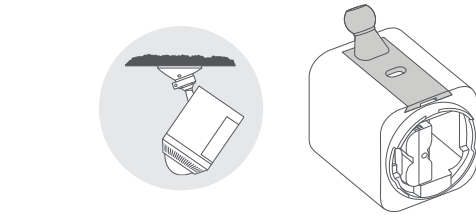
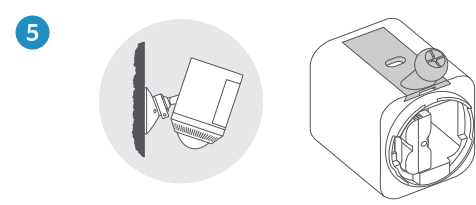
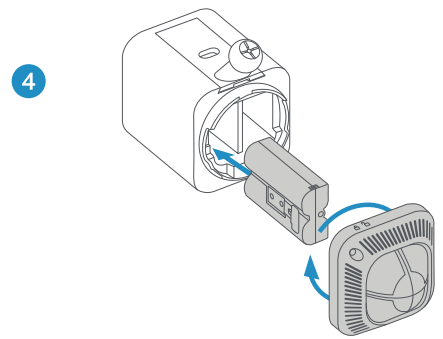
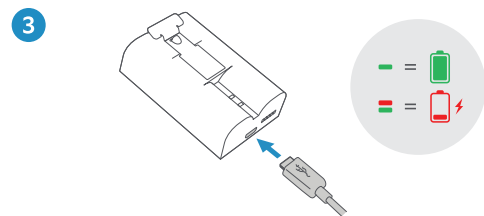
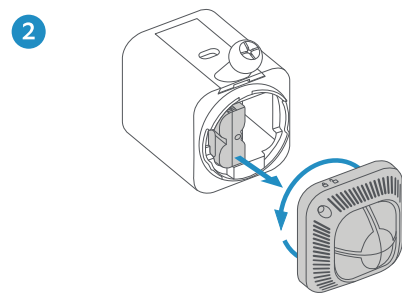

22-004429-03

8

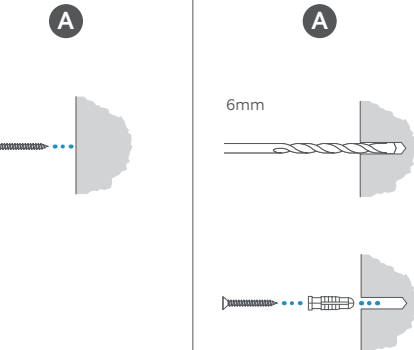
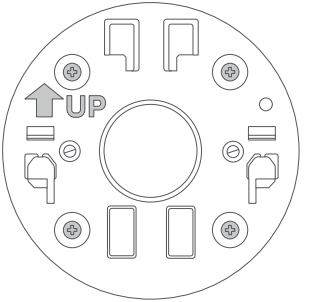

**WARNING!**  
Only use the included mounting screws  
when securing the mounting plate.

**CAUTION! DO NOT drill into your home's  
electrical wiring**

**MISE EN GARDE ! Ne percez pas le câblage  
électrique de votre maison**

**ATTENTION ! Veuillez n'utiliser que les vis  
de fixation fournies lors de l'installation de  
la plaque de fixation**

**PRECAUCIÓN: NO perfores ni taladres el  
cableado eléctrico de tu casa**

**ADVERTENCIA: Utiliza únicamente los  
tornillos de montaje incluidos para fijar  
la placa de soporte**

9

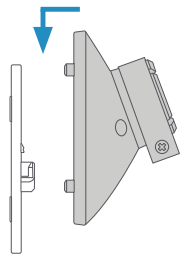

10

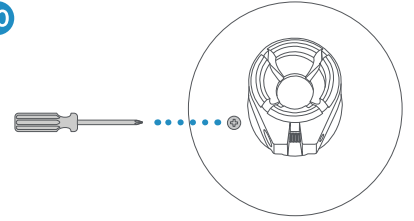

11

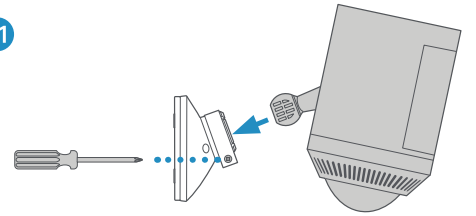

12

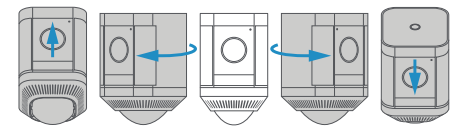

13

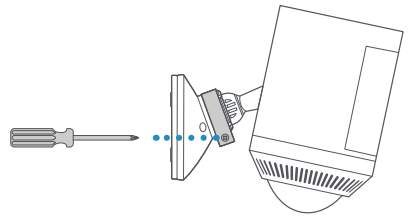

### Free Ring Protect Plan for 30 days.

Your new device comes with a free, 30-day trial of **Ring Protect**. This comprehensive subscription service lets you review, save, and share your video and photo history anytime so you never miss a moment.\*

To continue using Ring Protect after your free trial ends, visit [ring.com/protect-plans](https://ring.com/protect-plans) to compare plans and pricing.

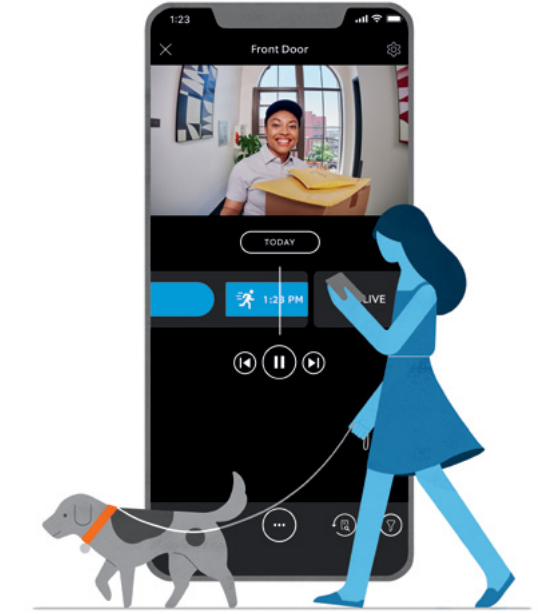

\*Your free trial isn't applicable for locations with an existing Ring Protect subscription. See [ring.com/protect-plans](https://ring.com/protect-plans) to learn more about your plan's retention period.

### Plan de protection Ring Protect gratuit pendant 30 jours.

Votre nouvel appareil vous est livré avec un essai gratuit de 30 jours de **Ring Protect**. Ce service d'abonnement complet vous permet de consulter, d'enregistrer et de partager votre historique de vidéos et de photos à tout moment pour ne plus jamais rater un seul instant\*.

Pour continuer à utiliser Ring Protect après la fin de votre essai gratuit, visitez le site [ring.com/canada-protect-plans](https://ring.com/canada-protect-plans) pour comparer les plans et les prix.

\* Votre essai gratuit ne s'applique pas aux emplacements ayant déjà un abonnement à Ring Protect existant. Veuillez consulter le site [ring.com/canada-protect-plans](https://ring.com/canada-protect-plans) pour en savoir plus sur la période de maintien de votre plan.

### Plan de Ring Protect gratis por 30 días.

Tu nuevo dispositivo viene con una prueba gratuita de 30 días de **Ring Protect**. Este servicio de suscripción integral te permite revisar, guardar y compartir tu historial de video y fotos en cualquier momento para que no te pierda ningún evento\*.

Visita [ring.com/protect-plans](https://ring.com/protect-plans) para comparar planes y precios, y continuar utilizando Ring Protect después de que expire la prueba gratuita.

\*La prueba gratuita no está disponible en domicilios con una suscripción de Ring Protect existente. Visita [ring.com/protect-plans](https://ring.com/protect-plans) para obtener más información sobre el periodo de almacenamiento de tu plan.



[ring.com/help](https://ring.com/help)

[ring.com/callus](https://ring.com/callus)

For information on our warranty, theft protection, and Ring Protect Plans, visit [ring.com/legal](https://ring.com/legal)

Pour en savoir plus sur nos programmes de garantie et de protection contre le vol ainsi que sur Ring Protect, consultez [ring.com/legal](https://ring.com/legal)

Para obtener información sobre nuestra garantía, protección antirrobo y planes Ring Protect, visita [ring.com/legal](https://ring.com/legal)

© 2022 Ring LLC or its affiliates. Ring and all related marks are trademarks of Ring LLC or its affiliates.

